



**CATALOGO
CAMINETTI
COMPLETI DESIGNER**

Aggiornato a ottobre 2005



D E S I G N

EDILKAMIN TECNOLOGIA DEL FUOCO

La storia della civiltà nasce con il dominio del fuoco. Prometeo regalò agli uomini questo preziosissimo dono, e da allora la tecnologia del calore ha fatto innumerevoli passi avanti.

Anche Edilkamin ha costruito la propria storia intorno al fuoco, rendendolo amico e sicuro senza togliergli fascino e magia. Abbiamo dedicato anni di esperienza, tutte le nostre energie e capacità progettuali per costruire prodotti sempre all'avanguardia e stilisticamente innovativi.

Nelle nostre quattro unità produttive in Italia ed in Europa progettiamo e realizziamo prodotti che ci hanno portato ad essere leader nella tecnologia del fuoco e a farci apprezzare da consumatori attenti ed esigenti che desiderano firmare le loro case con un caminetto o una stufa Edilkamin, dettagli importanti per un arredamento prestigioso e alleati indispensabili per riscaldare la casa in modo più attento e consapevole.



LA GRANDE COLLEZIONE CAMINETTI COMPLETI

La storia di Edilkamin ha visto crescere la sua leadership non solo nella tecnologia, ma anche nelle proposte di design. Più di 200 rivestimenti offrono la possibilità di arredare tanti tipi di casa e di scegliere fra tanti stili diversi. **Linea Sintesi** (pagg. 12-15), **Caminetti classici** (pagg. 16-27), **contemporanei** (pagg. 28-43), **rustici** (pagg. 44-69), **serie standard** (pagg. 70-81) e perfino **caminetti firmati da grandi designer italiani** (pagg. 4-11) potranno rendere la vostra casa ancora più bella ed accogliente. E la semplicità della filosofia Edilkamin viene incontro ai vostri problemi di spazio e alle vostre esigenze permettendovi di adattare vari tipi di rivestimento al focolare più indicato per voi. I nostri esperti vi aiuteranno a scegliere la soluzione migliore sia da un punto di vista tecnico che estetico. Per questo vi invitiamo a visitare le show room Edilkamin o il rivenditore autorizzato più vicino: avrete la possibilità di vedere tutte le novità ed avere una panoramica più completa su tutti i rivestimenti per il vostro caminetto.



SERIE DESIGN

Cinque caminetti unici, diversi per stile e carattere, ma tutti progettati con grande sensibilità e maestria.

PLANET

di Lino Codato

(pagina 9)

Caminetto completo incentrato sull'abbinamento di due materiali: la pietra/marmo e l'acciaio. L'interno del focolare è costituito dal monoblocco STATUS a convezione naturale.

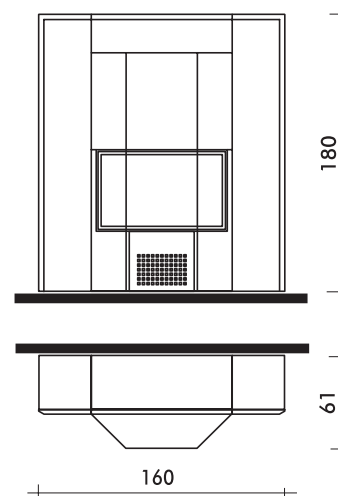

FOCO

modello 1
modello 2 (foto)

di Antonio Citterio

(pagina 7)

Caminetto dal design essenziale, realizzato interamente in ghisa. Basamento con comodo portello per la manutenzione dei ventilatori. Soglia del focolare incassata nel pavimento o semplicemente appoggiata, oppure sollevata ad altezza piano fuoco sul telaio metallico.

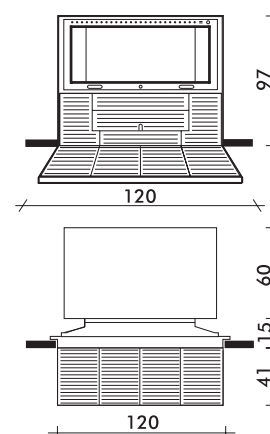

SQUARE

di Lino Codato

(pagina 10-11)

Un grande pannello quadrato, proposto in tre varianti di materiale: vetro, acciaio, marmo.

Caminetto completo di focolare monoblocco FORTE a convezione naturale.

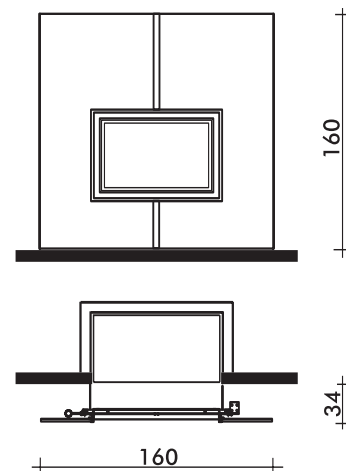

FRAME

di Lino Codato

(pagina 6)

Cornice dalla linea essenziale, realizzata in massello di marmo bardiglio o travertino; completa di focolare monoblocco FORTE a convezione naturale.

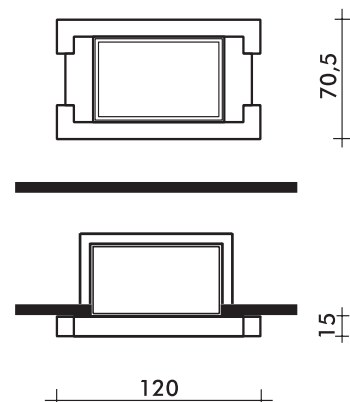

TIMES

di Lino Codato

(pagina 8)

Cornice in marmo massello lavorato ad alto-rilievo, proposto in due varianti di marmo; completa di focolare monoblocco FORTE a convezione naturale.

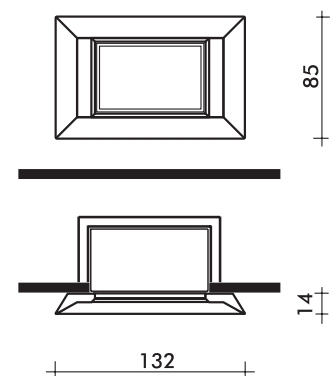



variante in
marmo bardiglio



Frame travertino





variante in marmo
rosso verona



Times
marmo tigrato orientale



ardesia/metallo grigio



marmo
arabescato bianco
/metallo nero

Planet
ardesia/metallo rosso



variante in
vetro antracite



variante in vetro blu



variante in
acciaio inox



Square
vetro bianco



Square marmo arabescato bianco

TERMOCAMINETTI MONOBLOCCO

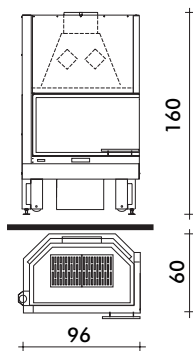

TITANO

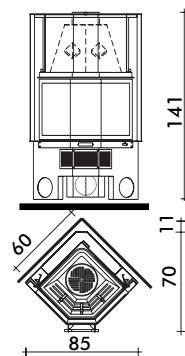

EGO

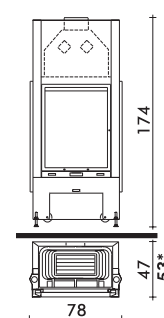

STILE piano
*STILE curvo

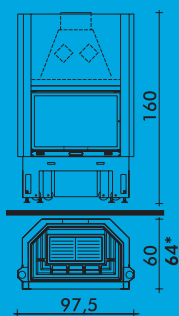

FORTE piano
*FORTE curvo

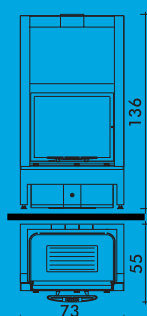

PLUS

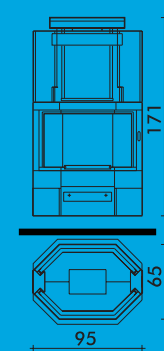

GIANO

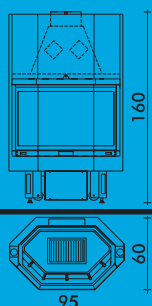

STATUS

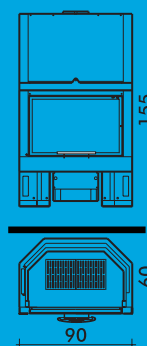

TER/F

■ TERMOCAMINETTI AD ACQUA per alimentazione termosifoni



ACQUATONDO sfera



ACQUATONDO 22/29
piano con portellone

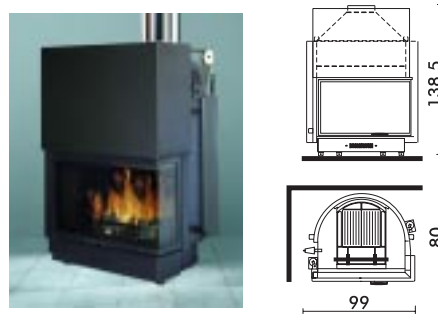

ACQUATONDO un lato vetrato



ACQUATONDO 22/29
prismatico

■ CAMINETTI APERTI DA RISCALDAMENTO



SPAZIO

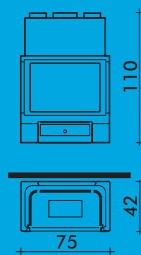

UNIVERSAL

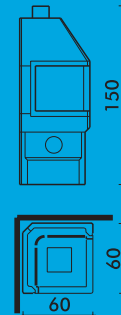

CAMINETTI APERTI con interno in ghisa



NK75

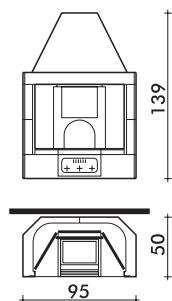

K QUADRO

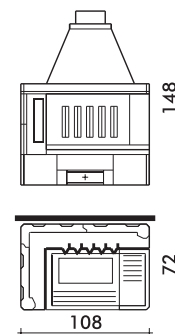

K75DS

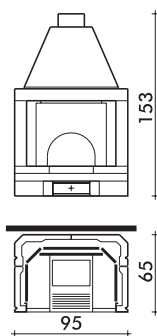

K TONDO

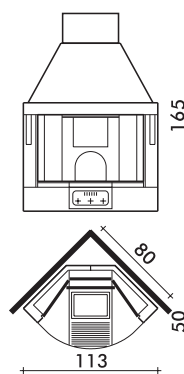

K102

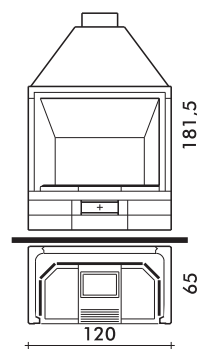

CAMINETTI APERTI con interno in Arveco®



CORNER

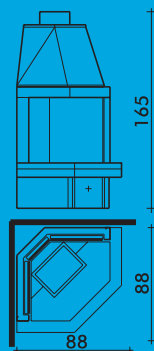

MIDI

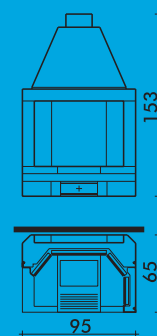

MAXI

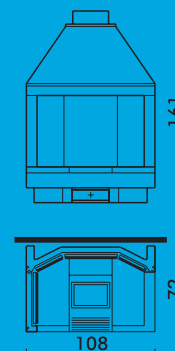

FIREBOX® e PELLBOX - frontale in ghisa - frontale in acciaio - funzionamento a legna; a pellet (pellbox)

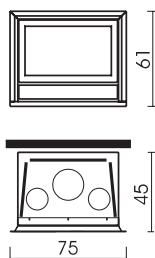

LUCE 54

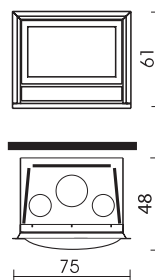

LUCE TONDA 54

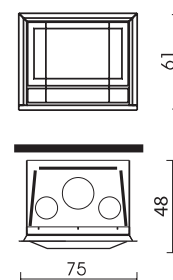

LUCE PRISMATICA 54

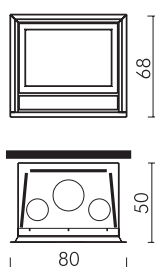

LUCE 62

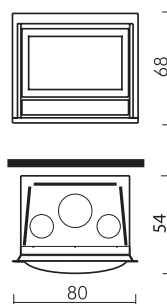

LUCE TONDA 62

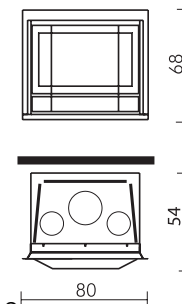

LUCE PRISMATICA 62

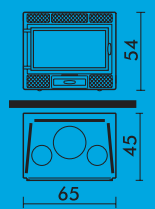

DECO

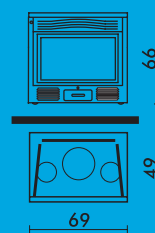

PIANA

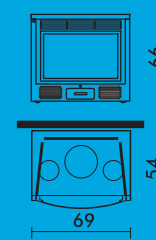

TONDA

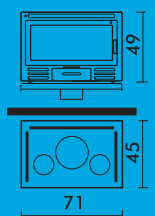

RIGA 49

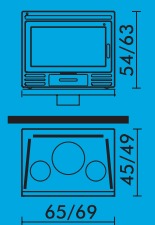

RIGA 54/62

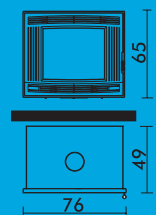

PELLBOX (funzionamento a pellet)

INDICE ALFABETICO

Abaco medio	pag. 56	Dolly	36	Maracaibo	77
Abaco piccolo	57	Domino	54	Marta	41
Ala angolare	28	Eclisse	16	Maya lati chiusi	35
Ala parete	30	Electra	17	Maya un lato aperto	34
Ala un lato aperto	29	Elios	66	Minorca	71
Alicante	24	Filorosso lati chiusi	42	Modulare	68
Aliseo	61	Filorosso un lato aperto	43	Modulo	67
Amelia	60	Foco	7	Novella medio	50
Andorra	78	Formentera	79	Novella piccolo	51
Aprica	47	Frame	6	Onda	38
Arabesque	15	Gabriella	52	Parigi	18
Arabesque tigrato	14	Gibilterra	79	Planet	9
Aragona	78	Giotto allungato	55	Roma	21
Bahia	74	Giotto base	54	Royal	55
Canaria	22	Gold	37	Samo	27
Caracas	75	Iron	13	Sahara	12
Carousel	23	Lady medio	33	Saxon	63
Cartagena	76	Lady piccolo	32	Silver	13
Charleston	22	Lego	59	Square	10
Class	19	Lente	26	Stone	62
Claudia	66	Levante	45	Tema	53
Combinato	69	Linares	70	Tenerife	72
Cordoba	81	Lisbona	20	Teorema	40
Cortina	46	Losanna	25	Times	8
Dama	64	Luisa N	48	Tosca	23
Dea	41	Luisa V	49	Tris	31
Dedalo	58	Madera	80	Vittoria	69
Derby	65	Maestrале	44		
Diva	39	Malaga	73		

INDICE PER FOCOLARE

Acquatondo Sfera

Bahia, Caracas, Cartagena, Maracaibo

Acquatondo lato vetrato

Gibilterra un lato vetrato, Madera, Tenerife

Acquatondo piano

Gibilterra parete, Saxon, Cordoba, Malaga

Acquatondo prismatico

Andorra, Formentera, Minorca, Linares, Cortina

Corner

Gabriella

Firebox 54 - Deco, Riga, Luce.

Alicante, Arabesque, Aragona, Dama, Dea, Dedalo, Diva, Dolly, Domino, Filorosso, Giotto, Iron, Lente, Roma, Royal, Sahara, Silver, Stone

Firebox 62 - Piana, Tonda, Riga, Luce

Arabesque, Domino, Iron, Parigi, Roma, Sahara, Silver, Stone

Forte

Class, Dea, Domino, Electra, Filorosso, Frame, Gibilterra, Levante, Lisbona, Losanna, Maya, Parigi, Roma, Royal, Samo, Saxon, Square, Times, Tosca

Ego

Abaco, Ala, Elios, Lady, Novella, Onda, Tris

K102

Amelia uno, Parigi uno, Roma uno

K75DS lati chiusi

Alicante, Dama, Gibilterra, Giotto, Lente, Lisbona, Parigi due, Roma due, Tosca

K75DS un lato aperto

Derby, Filorosso, Lego, Luisa, Tema

K75S - NK75

Alicante, Amelia due, Aragona, Dea, Filorosso, Lente, Lisbona, Parigi due, Roma due, Saxon, Tosca

K Quadro

Luisa, Modulo, Modulare, Vittoria

K Tondo

Abaco, Claudia, Elios, Novella

Maxi

Combinato, Modulo, Modulare

Midi lati chiusi

Alicante, Dama, Gibilterra, Giotto, Lente, Lisbona, Parigi due, Roma due, Tosca

Midi un lato aperto

Derby, Filorosso, Lego, Luisa, Tema

Plus

Aliseo, Class, Dedalo, Diva, Gold, Lisbona

Spazio

Amelia, Royal

Status

Abaco, Ala, Claudia, Cortina, Elios, Lady, Novella, Planet, Stone, Teorema, Tris

Stile

Aprica, Canaria, Carousel, Charleston, Eclisse, Eiffel*, Eiffel Keramik*, Empire*, Empire Marmor*, Maestrale

Ter/F

Class, Gibilterra, Lisbona, Maya, Parigi, Roma, Saxon, Tosca

Titano

Ala (parete), Derby, Filorosso, Lego, Luisa V, Maya, Tema,

Universal

Gabriella, Marta

* vedere catalogo stufe

ACCESSORI PER L'USO

LINEA DOMUS

paletta per brace,
l. 80 cm



braciere a barchetta in ghisa cm 60x30



cm 27x16x64h



Manici ottonati



Manici legno



Manici acciaio



 **EDILKAMIN**
TECNOLOGIA DEL FUOCO